

# DESARROLLO DEL TETRAEDRO

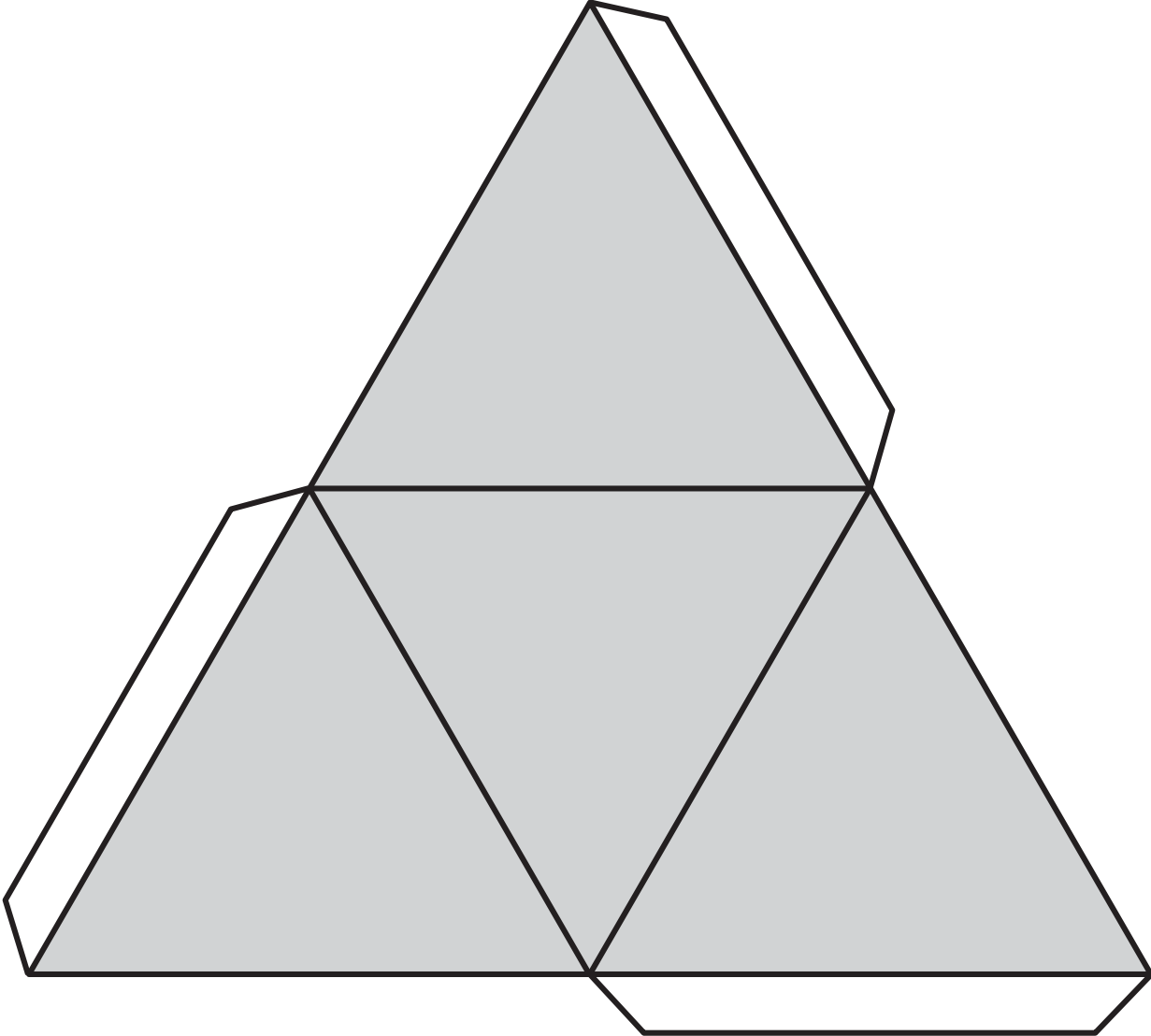

# DESARROLLO DEL CUBO O HEXAEDRO

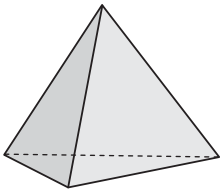
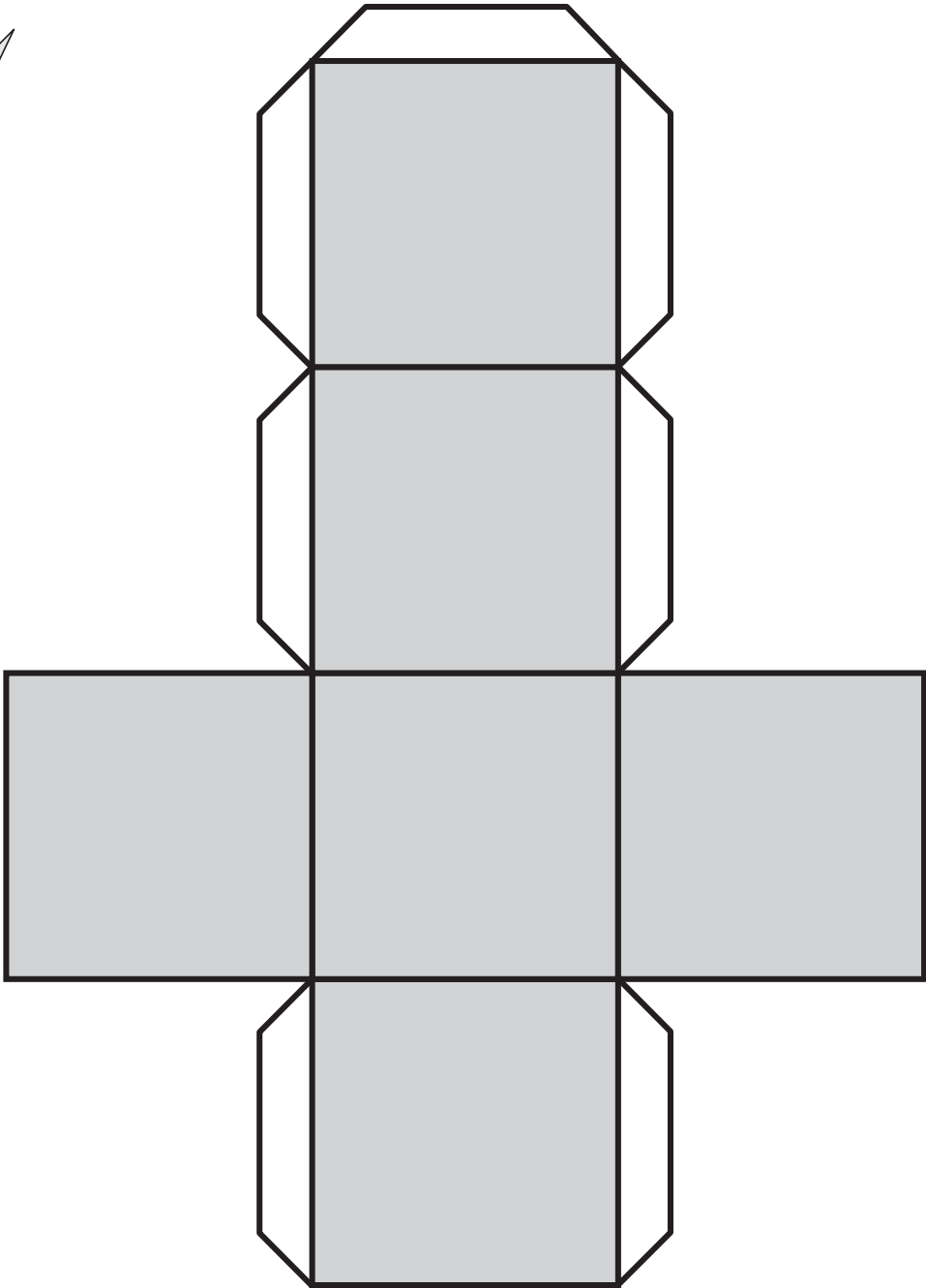
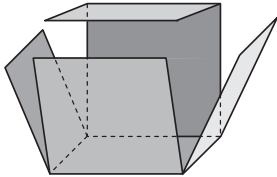
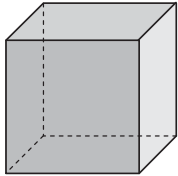

# DESARROLLO DEL OCTAEDRO

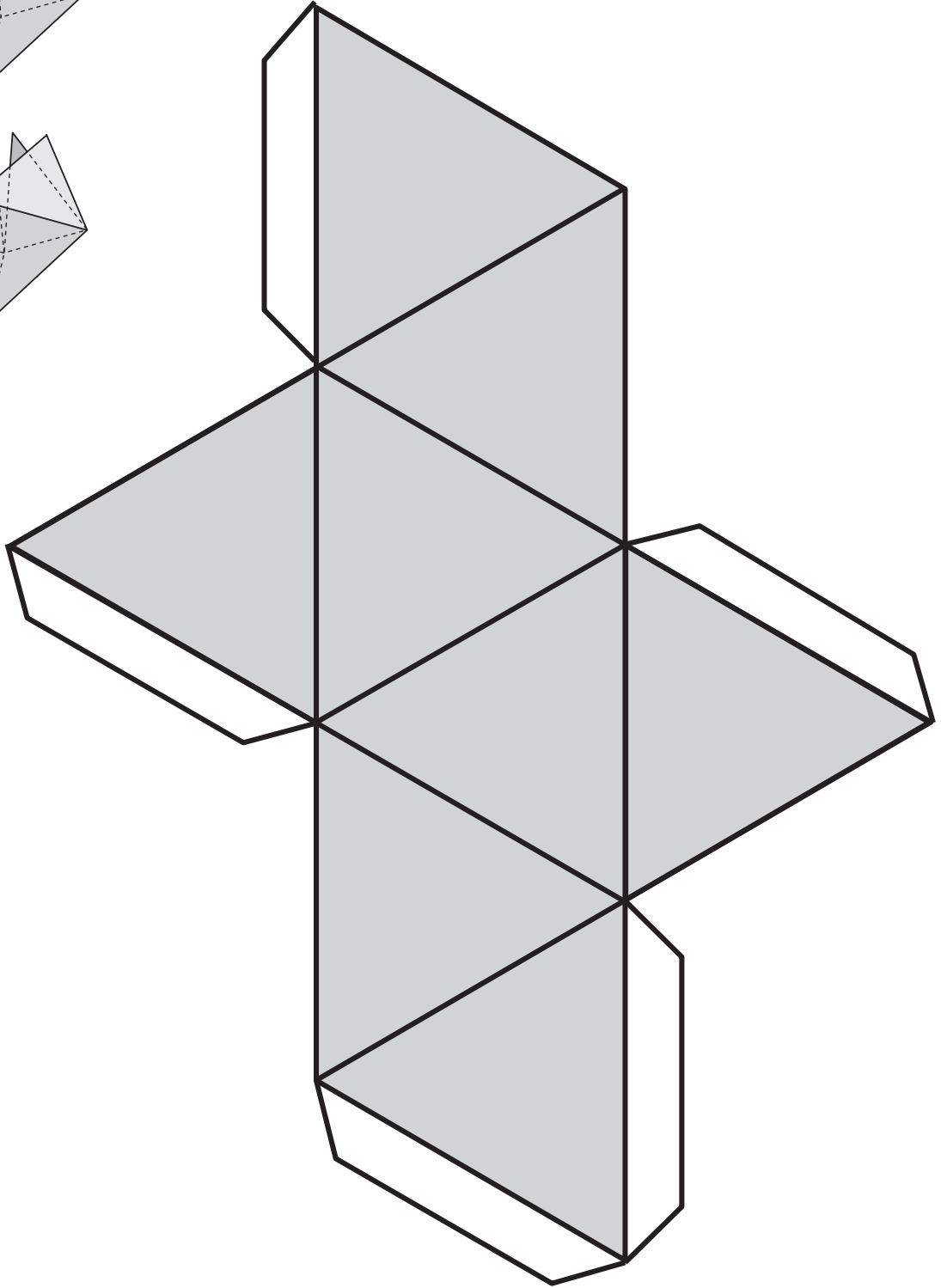
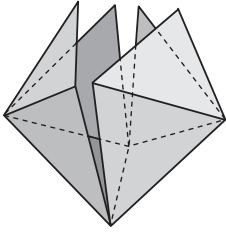
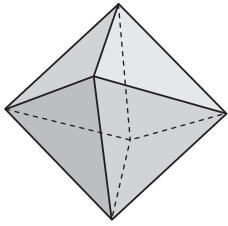

# DESARROLLO DEL DODECAEDRO

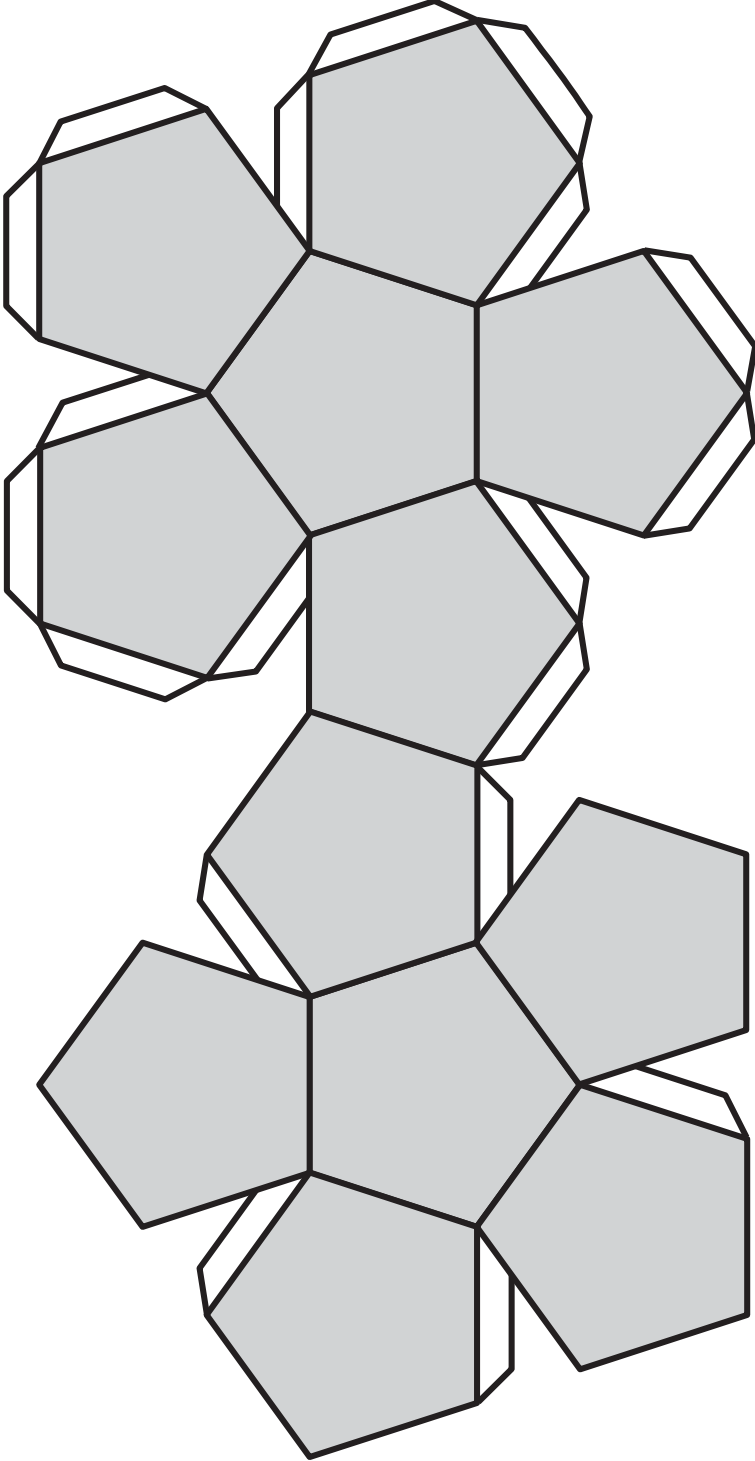
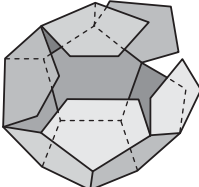
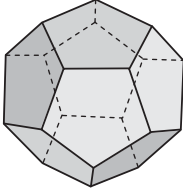

# DESARROLLO DEL ICOSAEDRO

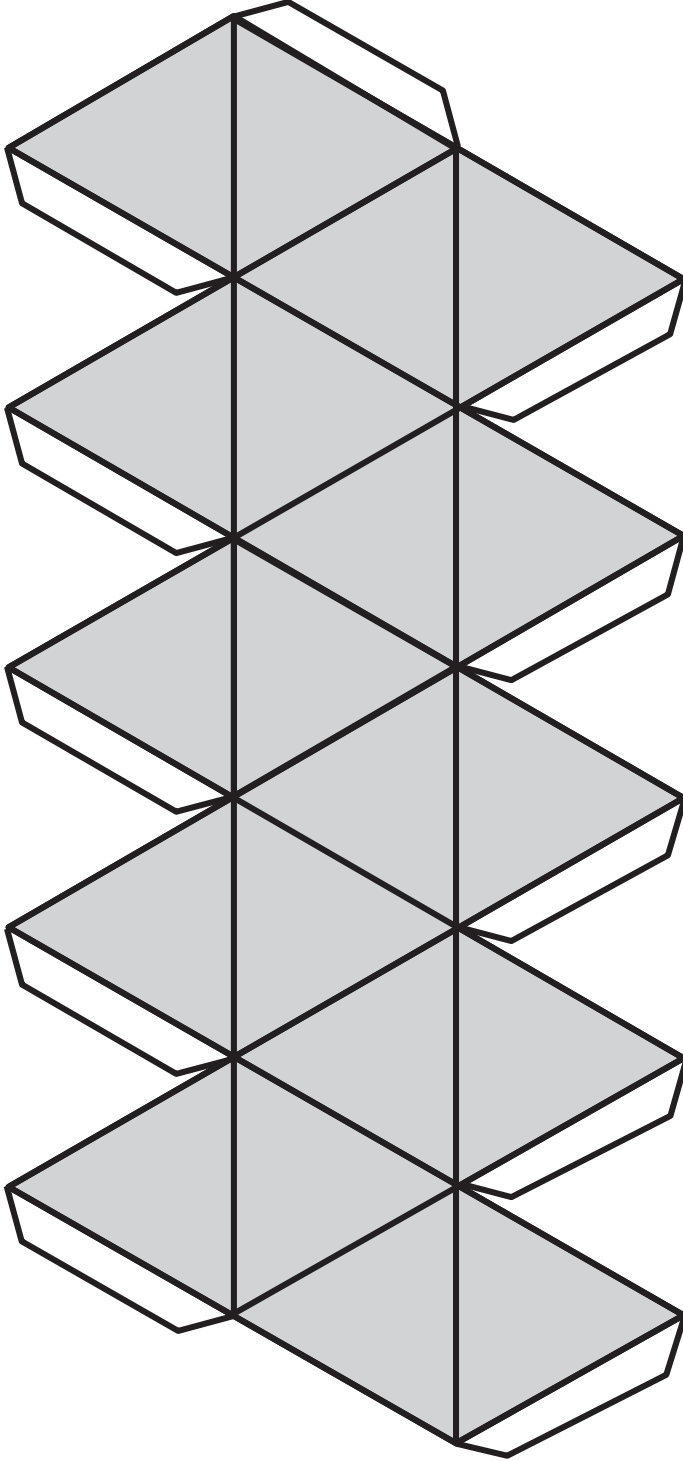
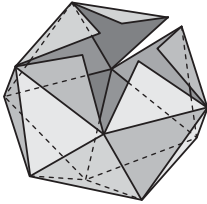
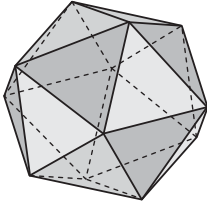

DESARROLLO DEL ORTOEDRO  
O PRISMA CUADRANGULAR RECTO

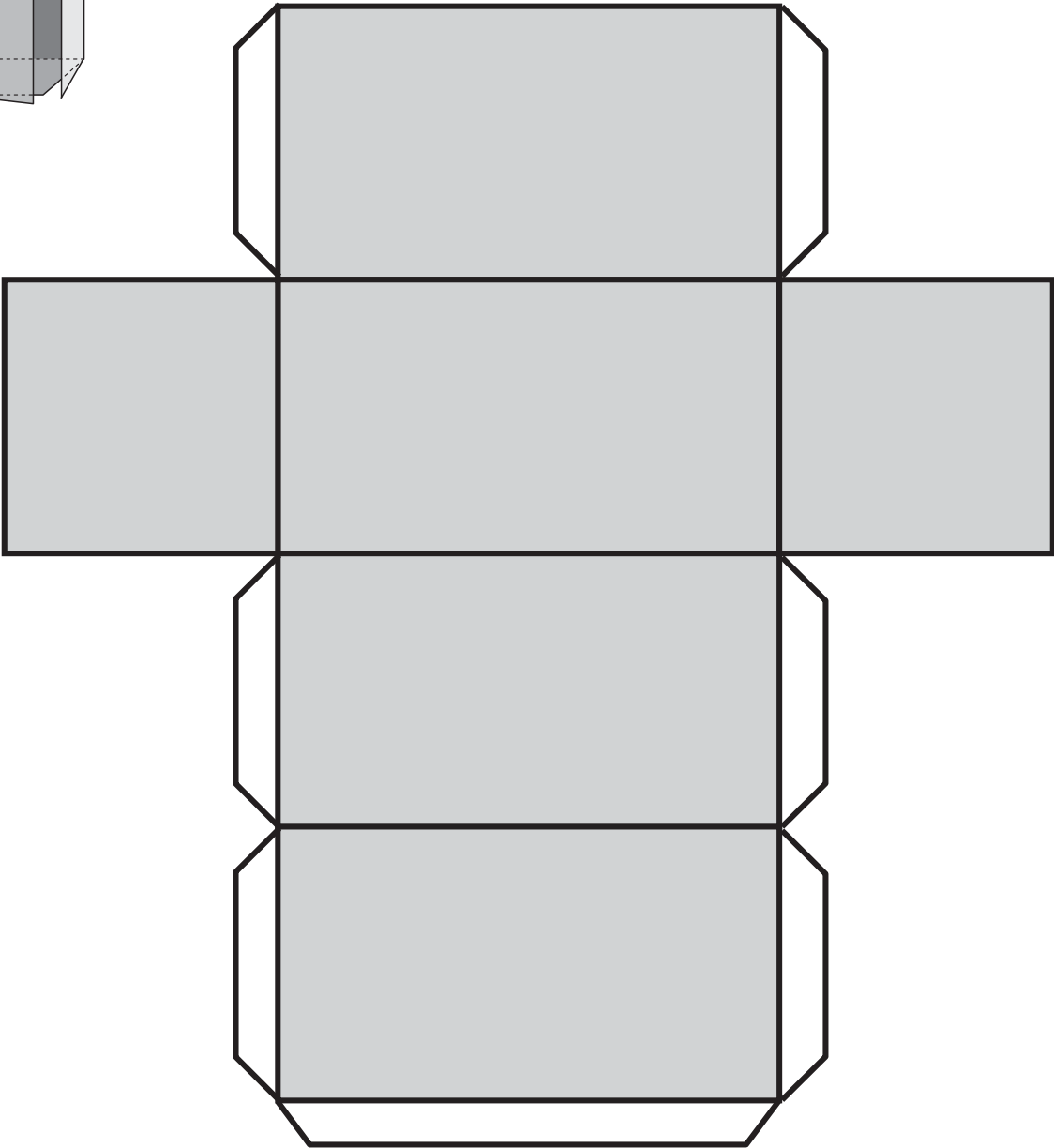
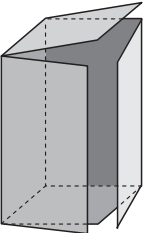
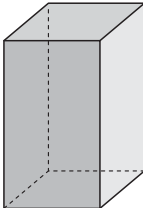

# DESARROLLO DEL PRISMA HEXAGONAL RECTO

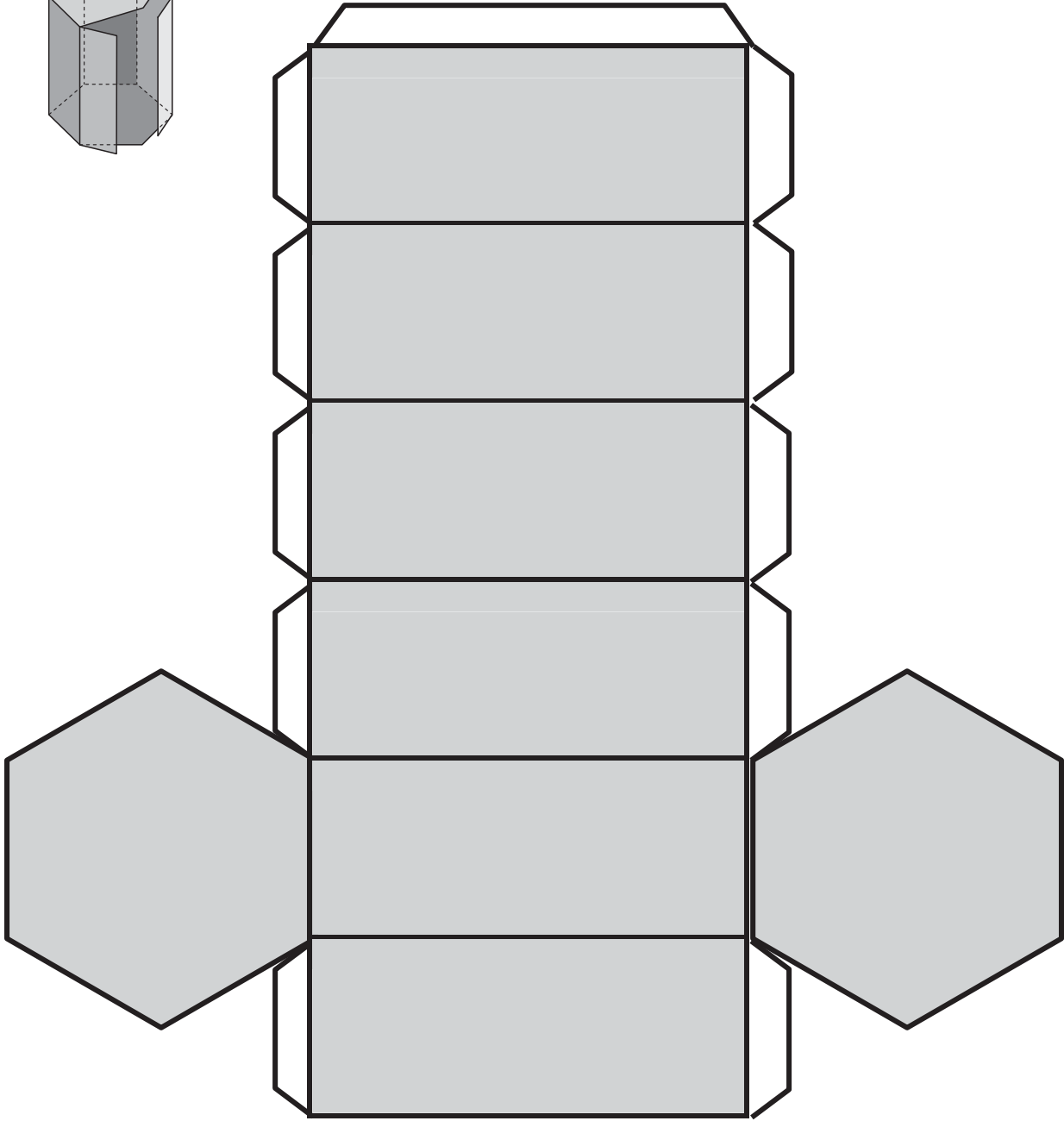
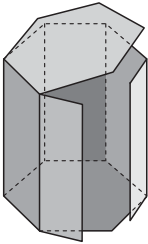
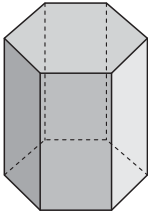

# DESARROLLO DE LA PIRÁMIDE CUADRANGULAR RECTA

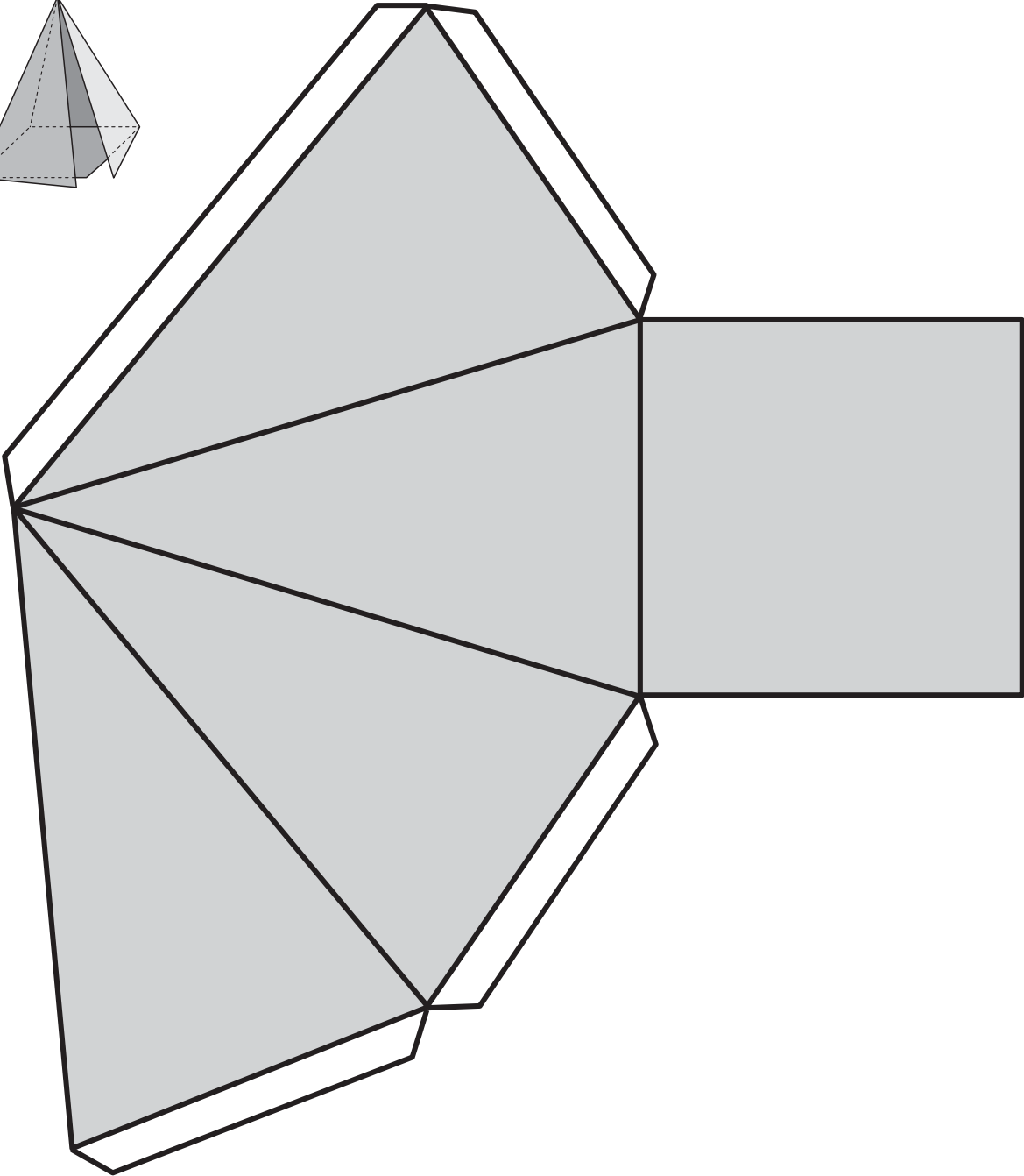
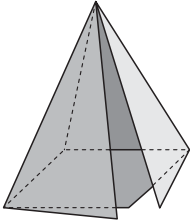
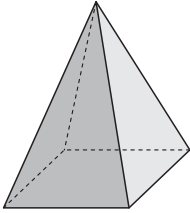



# DESARROLLO DE LA PIRÁMIDE HEXAGONAL RECTA

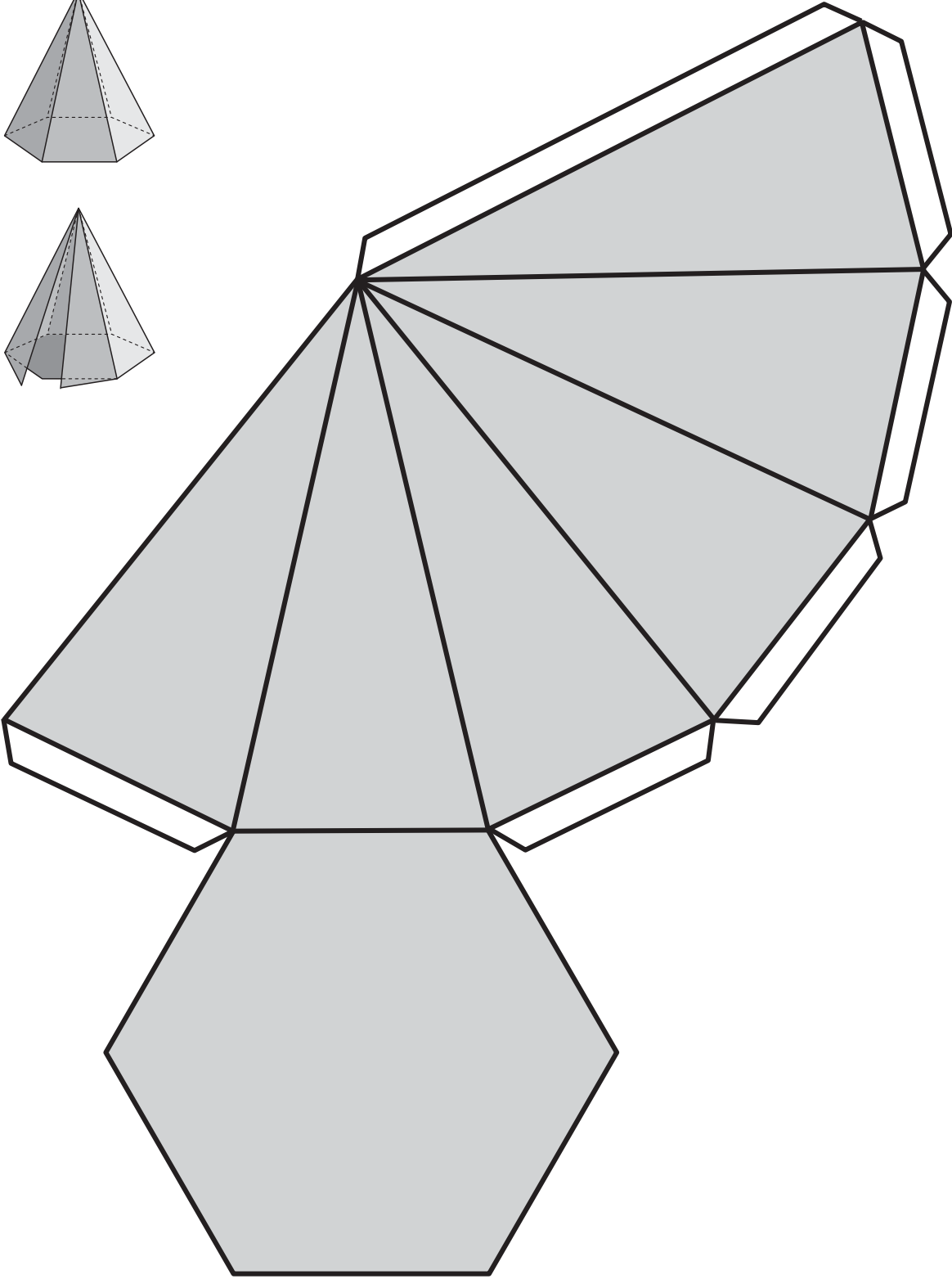
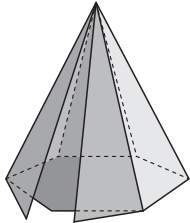
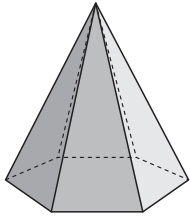

# DESARROLLO DEL TRONCO DE PIRÁMIDE CUADRANGULAR RECTO

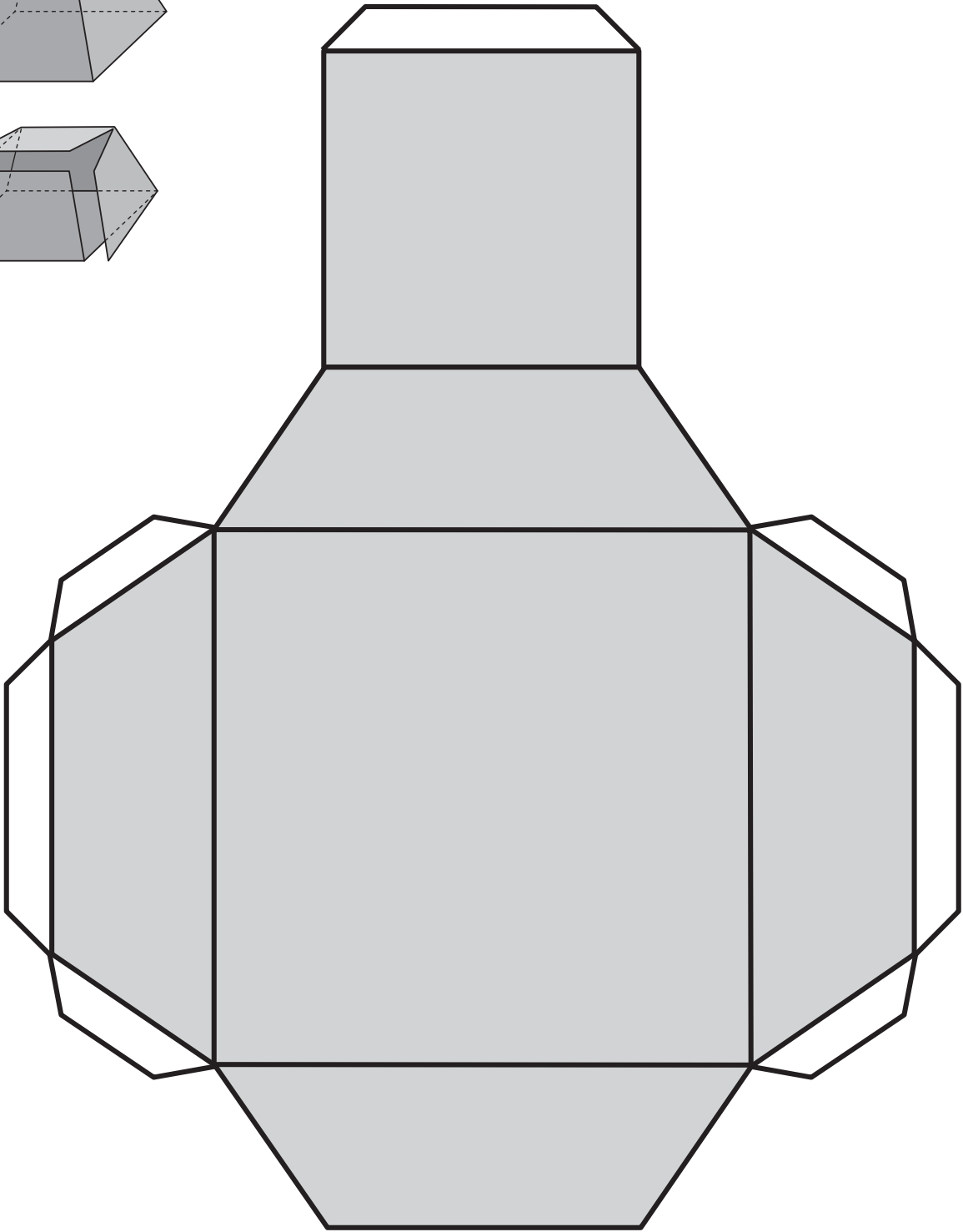
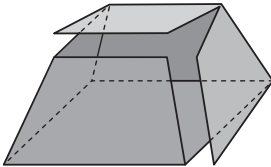
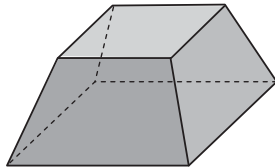

# DESARROLLO DEL TRONCO DE PIRÁMIDE PENTAGONAL RECTO

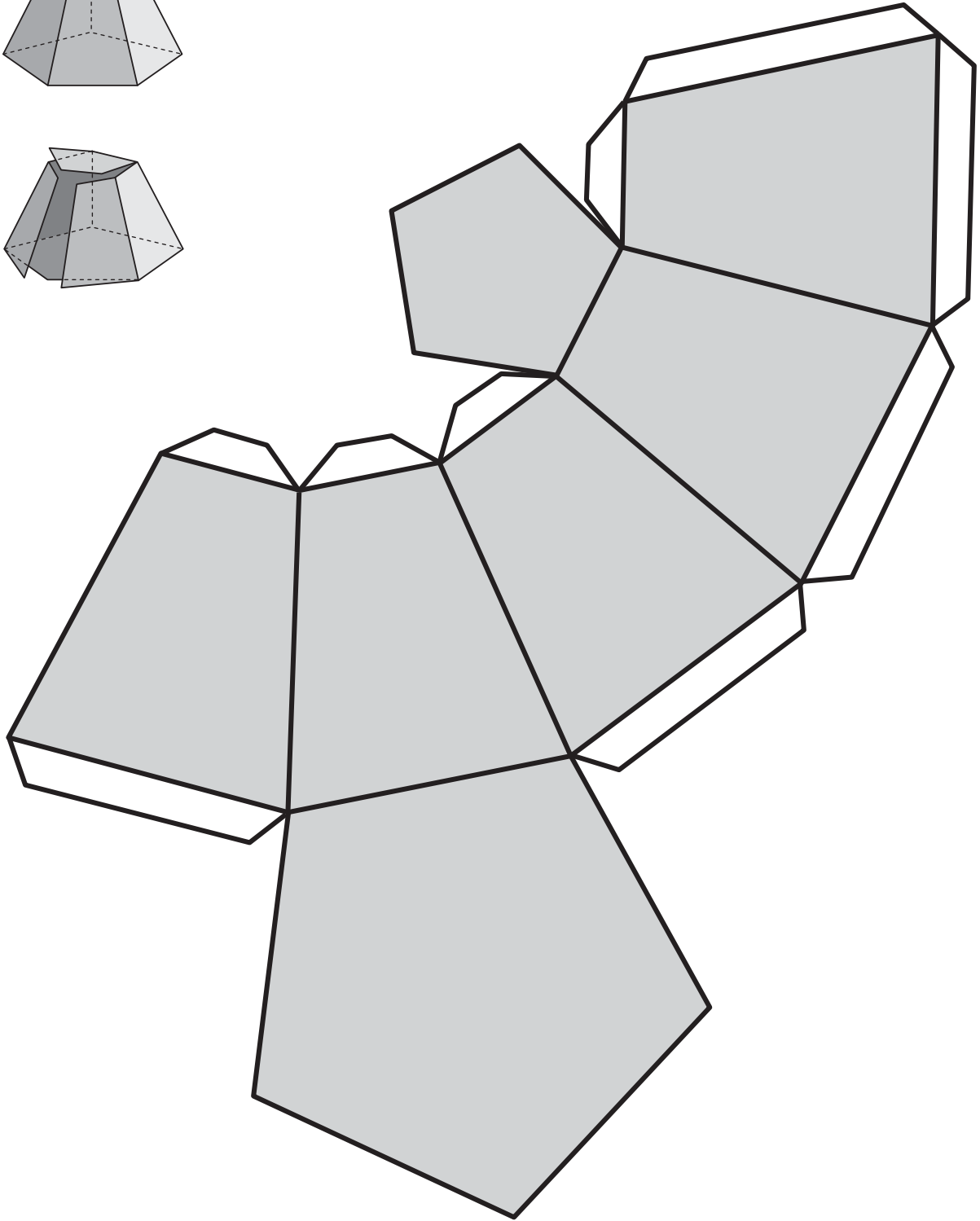
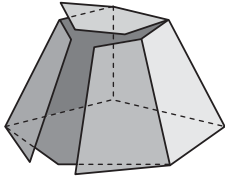
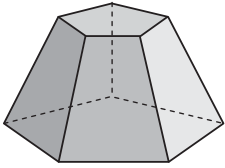

DESARROLLO DEL CILINDRO

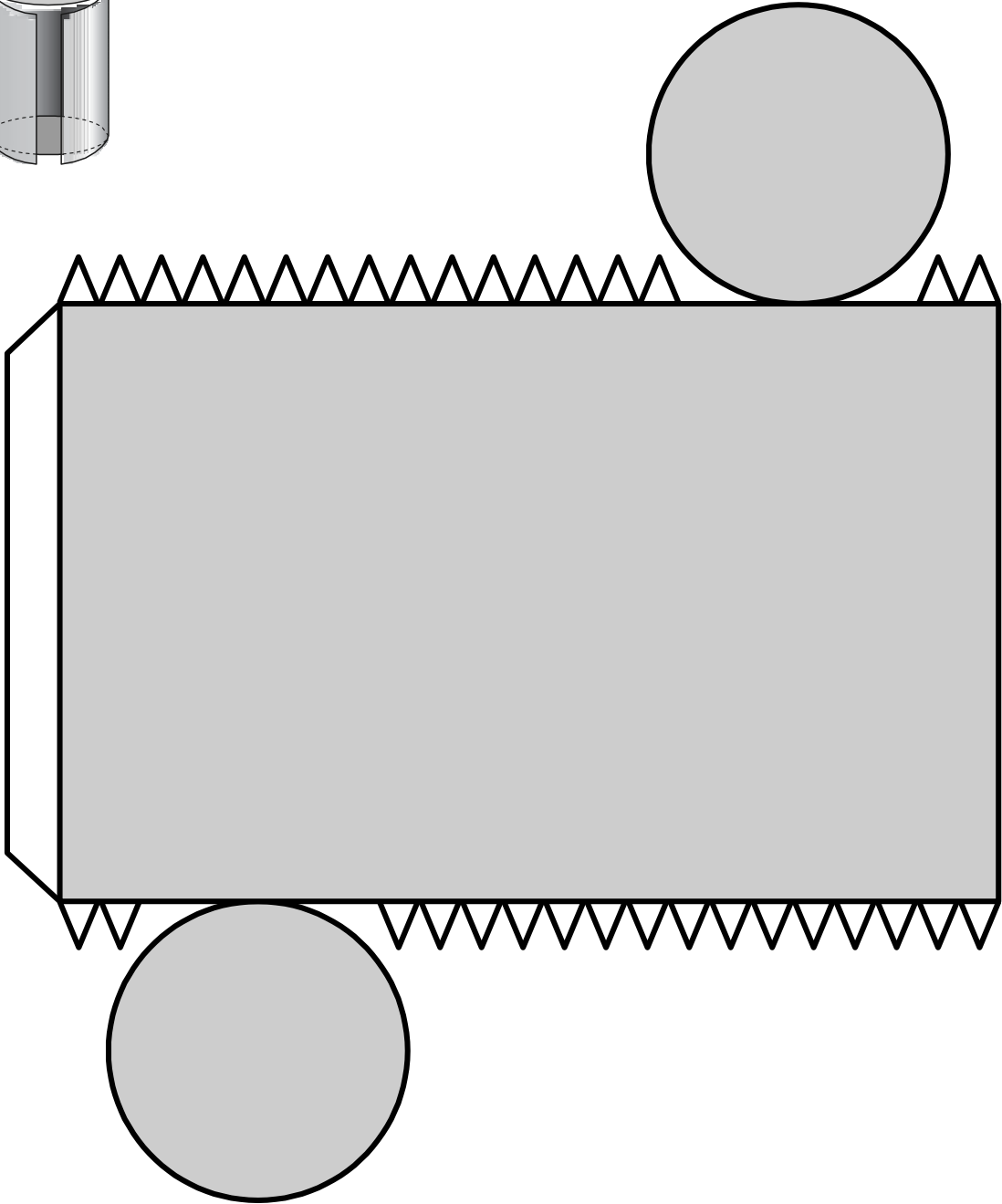
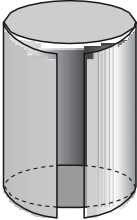
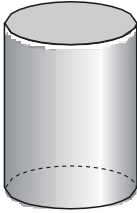

DESARROLLO DEL CONO

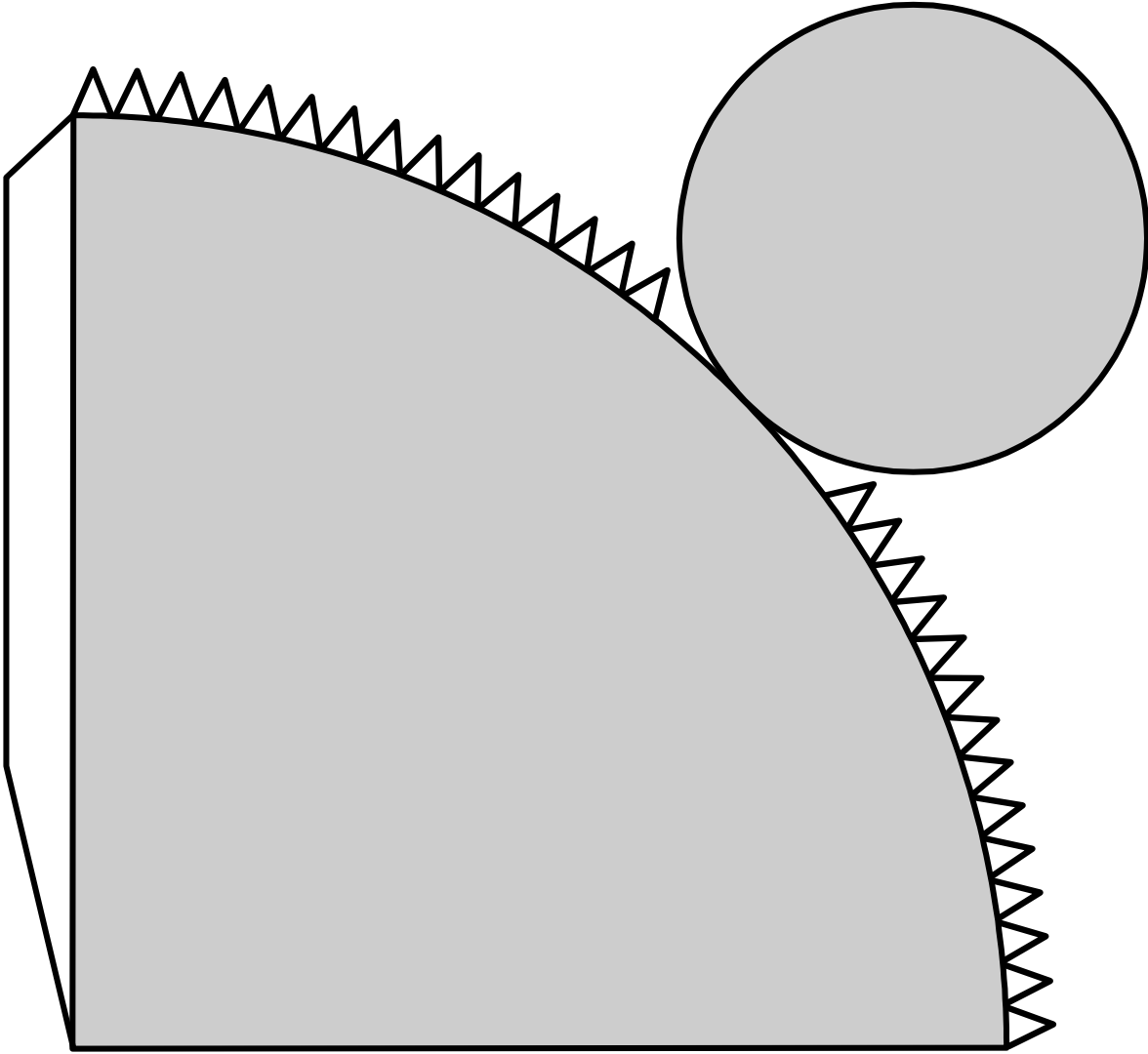
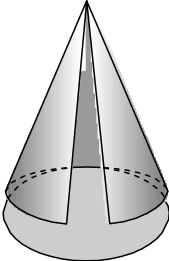
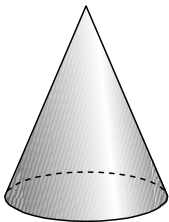

# DESARROLLO DEL TRONCO DE CONO

